

Varenummer: 0109090
 Beskrivelse: Seeger låsering AS 85X4.0
 Fjederstål
 Note: Monteres med ZGA tang

Mål

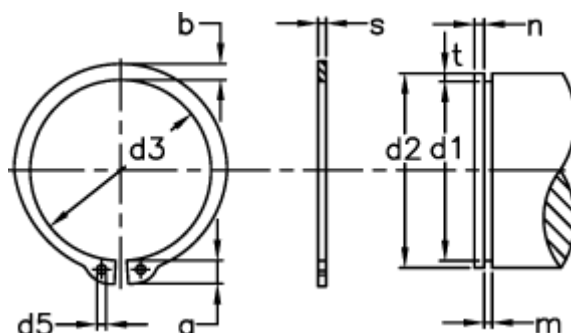

a max	= 10.0	d5 min	= 3.5	s	= 4.00
AN mm ²	= 458.0	FN kN	= 76.30	t	= 1.75
B	= 1.78	FRg kN	= 59.4	Tang	= ZGA-4
b	= 7.8	FR kN	= 383.0	tol	= -0.10
Betegnelse	= AS 85	g	= 3.0	tol	= +0,46 -1,10
d1	= 81.5	m min	= 4.15	tol	= -0.35
d2	= 85	n abl x 1000	= 6	vægt kg/1000	= 47.00
d3	= 79.5	Nominel træk	= 5.3		